

SISTEMAS DE CELOSÍAS

Lamas fijas y orientables



GRADHERMETIC

Industrial Gradhermetic, S.A.E.

GRADHERMETIC[®]

Industrial Gradhermetic, S.A.E.

SISTEMAS DE CELOSÍAS

Lamas fijas y orientables

“ Los sistemas de celosías Gradhermetic son conceptos arquitectónicos que logran el equilibrio perfecto entre la funcionalidad, elegancia y practicidad, ofreciendo a los profesionales de la arquitectura protección solar, visibilidad, modulación de la luz, ventilación y singularidad al edificio ”

Síguenos:



Industrial Gradhermetic, S.A.E.
Copyright © 2015. Reservado todos los derechos

Introducción

Protección Solar y Ahorro Energético	04
Tabla Fórmulas	05

PHALSOL
Monopared

ALUMINIO

Serie PH
(perfiladas)

PH 84	PH U 31
PH 134	PH U 81

08

Serie C
(extruidas)

C 100	C 150	C 180
C 130	C 160	

09

Serie CL
(extruidas)

CL 35	CL 50	CL 80
CL 40	CL 70	

12

Serie P
(perfiladas)

P 80 enc.	P 120
P 80 N	

13

Serie E
(extruidas)

E 77	E 150	E 220
E 100	E 170 (Bz)	E 250
E 120	E 190	E 300
E 145	E 200 (Bz)	E 400

14-16

ALUMINIO

Serie S
(perfiladas)

S 340	S 470	S 700
S 400	S 600	S 870

17

Serie HT
(perfiladas)

HT 205	HT 375
HT 220	HT 530

17

Serie BS
(extruidas)

BS 500
BS 1000

18

GRADPANEL
Tubulares

Serie M.EX AL
(troquelada)

M.EX FE 62	M.EX AL 110
M.EX FE 76	M.EX AL 115

20

Serie M.EX FE
(troquelada)

M.EX FE 62	M.EX FE 110
M.EX FE 76	M.EX FE 115

21

ACERO

Serie R
(perfiladas)

R 200	R 314	R 500
R 220	R 335	R 600
R 235	R 400	R 620
R 250	R 480	

22-23

Serie CL MAD
(maciza/Finger-Joint)

CL MAD 35	CL MAD 80
CL MAD 50	

24

MADERA

Serie P MAD
(maciza)

P MAD 100
P MAD 150

25

Singular
Especial



Singular

Varios

26-29

Especificaciones técnicas

Tabla de Acabados	31
Sistemas de Aplicaciones	32
Tabla de Aplicaciones	32
Tabla Limitaciones de lama Vertical	34
Tabla Limitaciones de lama Horizontal	35

SISTEMAS DE CELOSÍAS

PROTECCIÓN SOLAR Y AHORRO ENERGÉTICO

El sol es una fuente de energía que proporciona a la superficie terrestre aproximadamente 1000 W/m². Dicha energía incide en nuestros edificios proporcionando luz y calor a diario. A priori, esto es enormemente positivo para la eficiencia energética del edificio, puesto que disponemos de una fuente energética limpia (no contaminante) y gratuita. Pero la práctica nos demuestra que si no se controla la exposición del edificio a dicha energía, el sol en lugar de contribuir a su eficiencia energética, aumenta considerablemente su consumo energético.



Para poder efectuar el control requerido, los sistemas de protección solar GRADHERMETIC son una excelente solución, ya que permiten regular fácilmente la energía solar que penetra en el interior del edificio.

La regulación de lamas permite en invierno disminuir el consumo en calefacción, ya que durante el día con la apertura de lamas aumentamos la captación de energía solar hacia el interior del edificio. Durante la noche, con el cierre de lamas ayudamos a mantener la temperatura interior.

En verano, la estrategia de control de regulación debe cambiar, orientando las lamas de modo que impidan el paso de los rayos solares hacia el interior del edificio, permitiendo mantener una agradable temperatura ambiente y consiguiendo un sustancial ahorro en aire acondicionado. Durante la noche, la apertura de lamas y ventanas permite la circulación de aire, reduciendo otra vez las necesidades de aire acondicionado.

Las soluciones orientables también permiten al usuario regular el nivel lumínico del interior del edificio, aumentando el confort visual y eliminando los molestos deslumbramientos. Además, combinados con sistemas de regulación automáticos que controlen la orientación de lamas y los dispositivos de iluminación artificial, se puede optimizar el uso de iluminación natural, con el consecuente ahorro energético que ello supone.



SISTEMAS DE CELOSÍAS

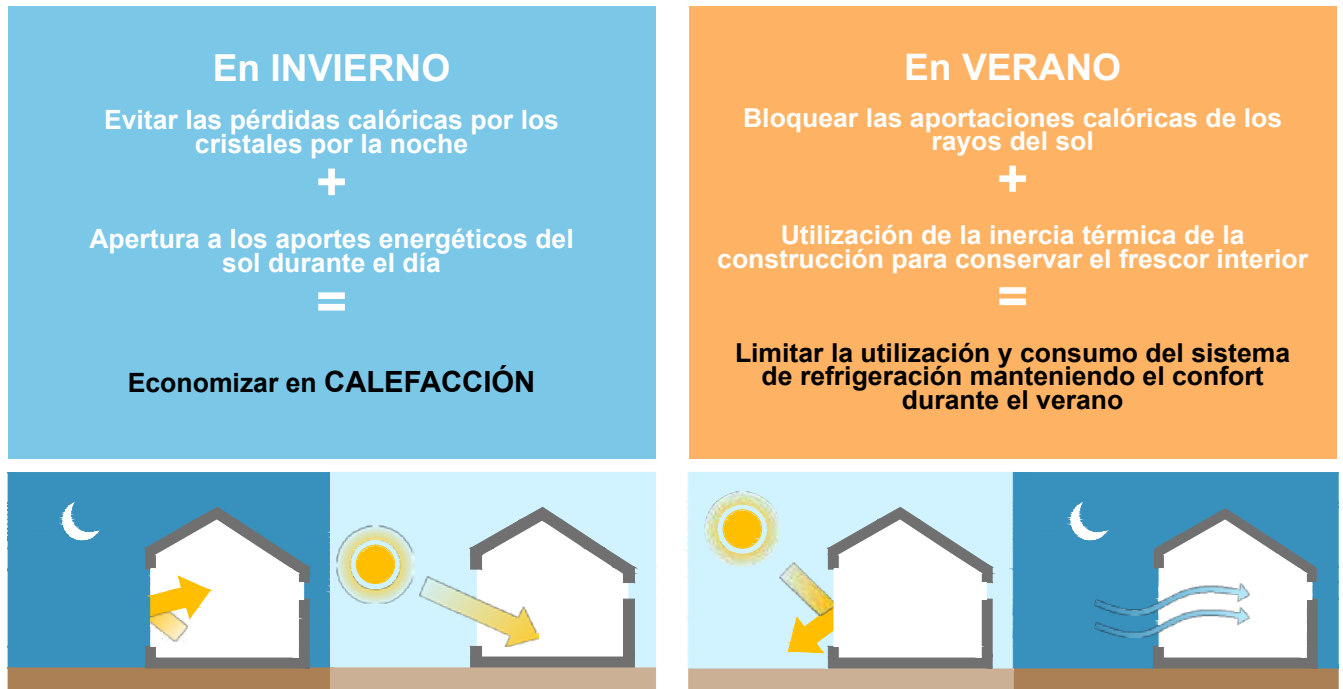

HEMISFERIO NORTE

Fachadas Orientación **SUR**

Sistemas de lamas horizontales tanto fijas como móviles. Las lamas verticales no son adecuadas ya que tienen que estar prácticamente cerradas para evitar la entrada del sol.

Fachadas Orientación **SUROESTE y SURESTE**

Sistemas de lamas móviles verticales y horizontales. La colocación de lamas fijas requiere un mayor estudio por parte del departamento técnico.

Fachadas Orientación **ESTE y OESTE**

La altura solar es escasa, los sistemas idóneos son los de lamas verticales. Las lamas horizontales no responden a las necesidades de esta orientación.





SISTEMAS DE CELOSÍAS

PHALSOL



PHALSOL

Monopared

ALUMINIO**Serie PH**
(perfiladas)PH 84
PH 134
PH U 31
PH U 81**Serie C**
(extruidas)C 100
C 130
C 150
C 160
C 180

APLICACIONES



PARAMENTO

MARCO
FIJO

CORREDERO

PRACTICABLE
BATIENTEPRACTICABLE
PIVOTANTE

PROYECTABLE

CORRUGABLE
BATIENTECORRUGABLE
PIVOTANTE

LEVADIZO

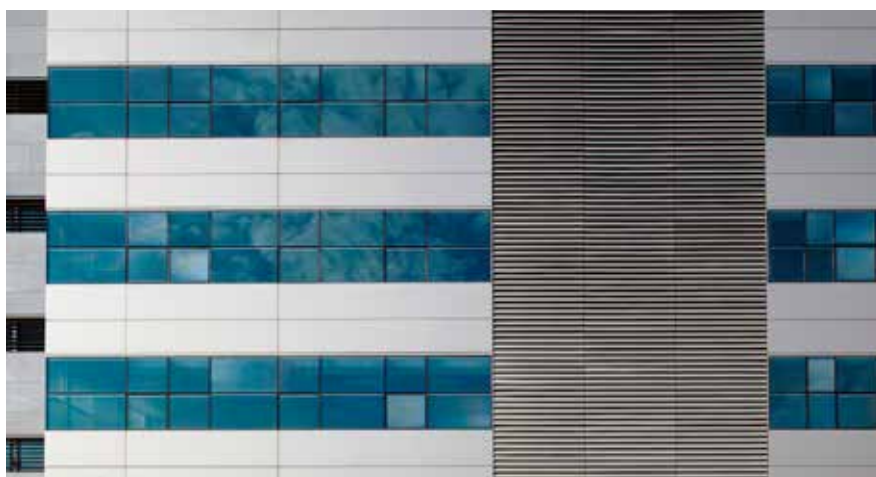

Celosías de aluminio, **monopared** de lamas **perfiladas**, fijas colocadas sobre vigueta con pinzas con diferentes inclinaciones y separación entre lamas. Posibilidad de lamas perforadas

SERIE PH

PRODUCTOS

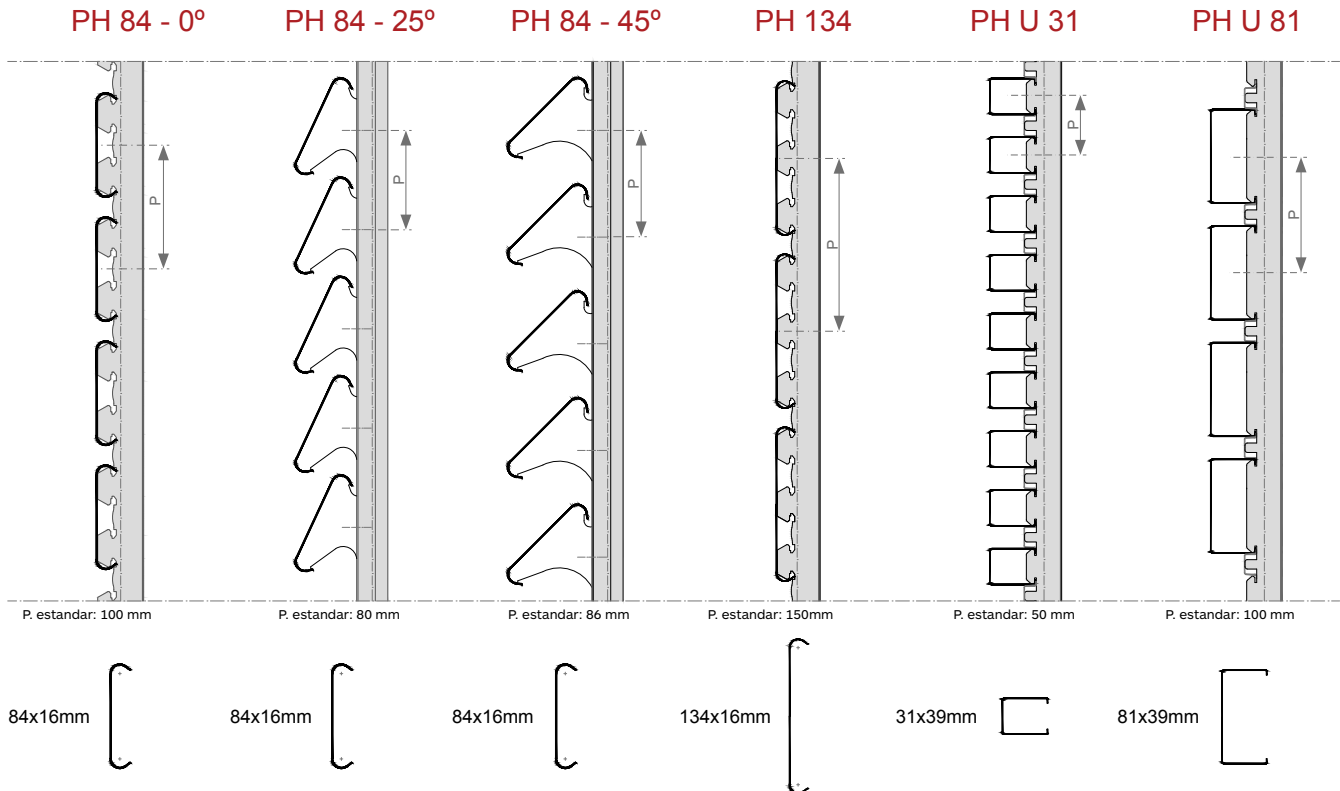

TIPOS DE VIGUETAS

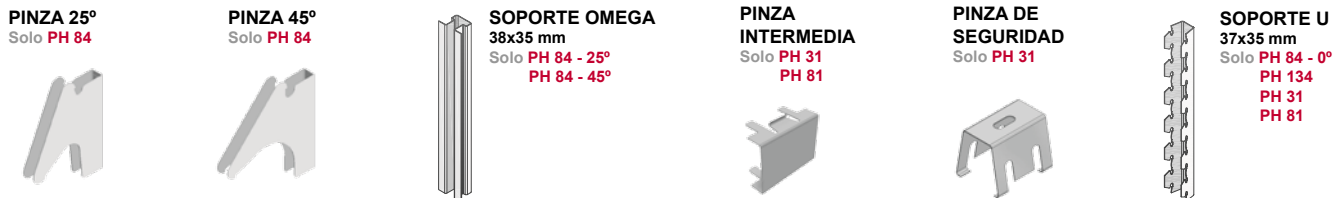

APLICACIONES

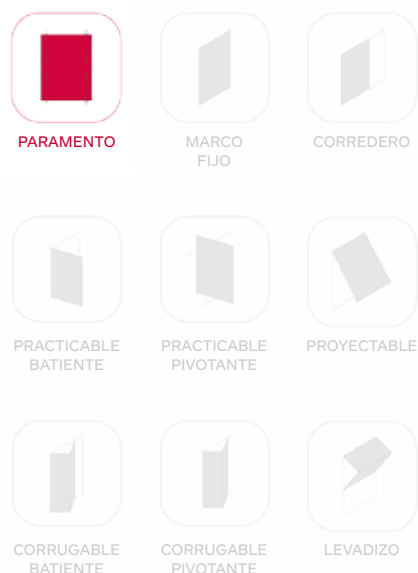

ESPECIFICACIONES

- Separación de lamas:

- PH U 31 / 81 : 9, 19, 29, 39 y 49 mm.
- PH 84 (0°) : 6, 16, 26, 36 y 46 mm.
- PH 84 (25°/45°) : Variable
- PH 134 : 6, 16, 26 mm.

- Posibilidad de lama perforada

- Pinzas:

- PH 84 : Pinza 25° y 45°.
- PH U 31 / 81 : Pinzas intermedias (9, 19, 29, 39 y 49 mm)
- PH U 31 : Pinza de seguridad



Celosías de aluminio, **monopared** de lamas **extruidas**, fijas y orientables colocadas sobre soportes de aluminio extruido con portalamas de diferentes inclinaciones y separación. Posibilidad de lamas perforadas

SERIE C

PRODUCTOS

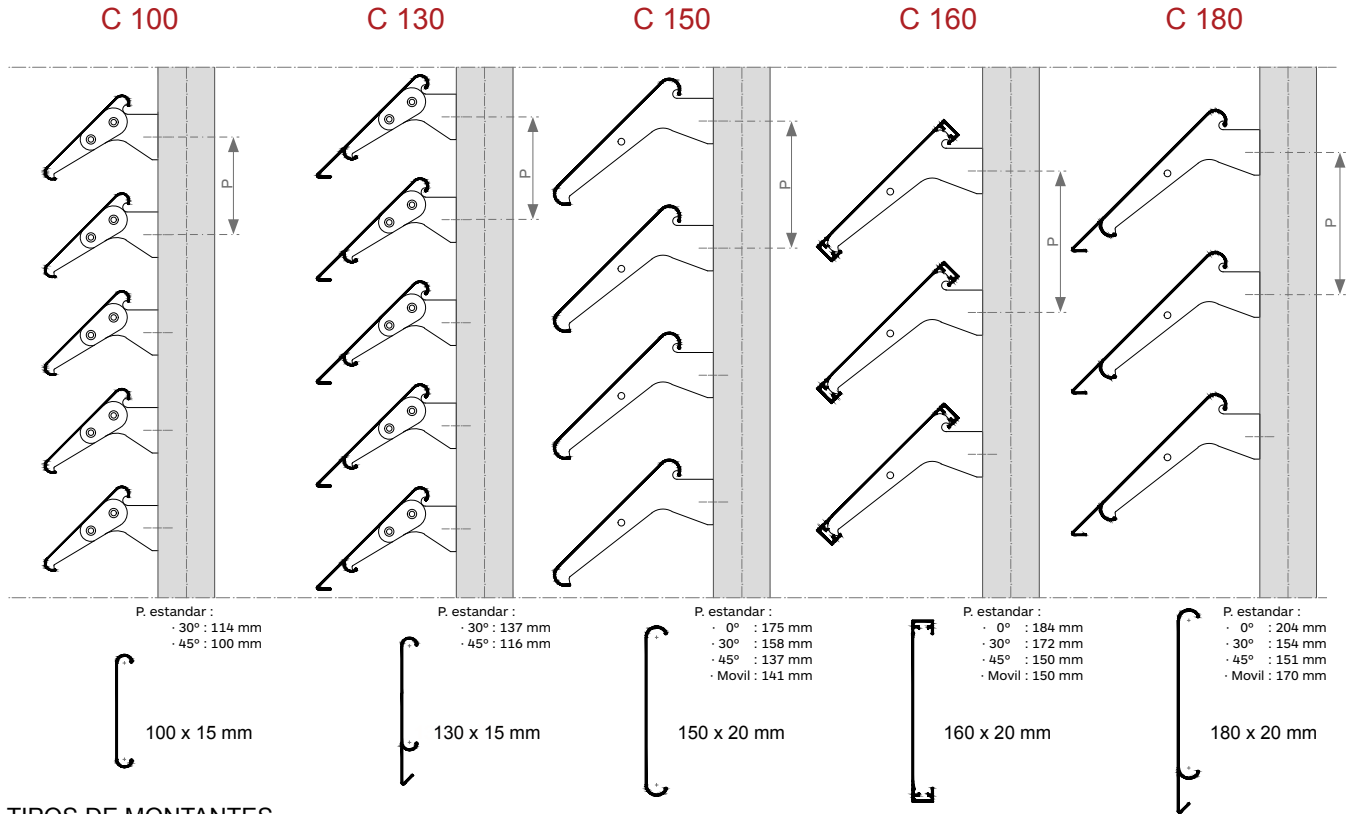

TIPOS DE MONTANTES



APLICACIONES

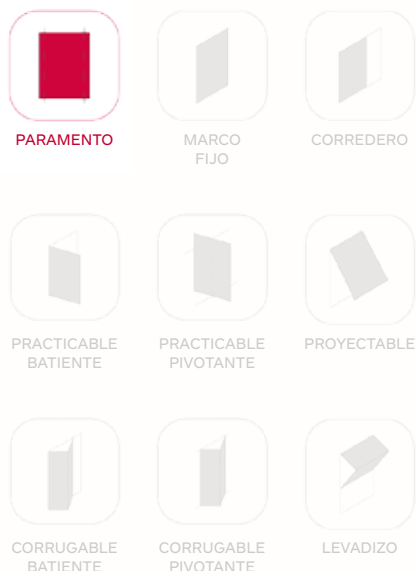

ESPECIFICACIONES

- Inclinación de lamas:

	C 100	C 130	C 150	C 160	C 180
45°	✓	✓	✓	✓	✓
30°	✓	✓	✓	✓	✓
0°	—	—	✓	✓	✓

- Orientación de lamas:

La Serie C de PHALSOL ofrece la posibilidad de orientar las lamas:

C 150 / C 160 / C 180

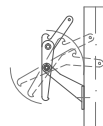

- Posibilidad de lama perforada:

C 150 / C 160 / C 180





SISTEMAS DE CELOSÍAS

GRADPANEL



GRADPANEL

Tubulares

ALUMINIO

Serie CL (extruidas)	Serie P (perfiladas)	Serie E (extruidas)	Serie S (perfiladas)	Serie HT (perfiladas)	Serie BS (extruidas)	Serie M.EX AL (troquelada)
CL 35	P 80 N	E 77	E 190	S 340	HT 205	M.EX AL 62
CL 40	P 80 enc.	E 100	E 200 (Bz)	S 400	HT 220	M.EX AL 76
CL 50	P 120	E 120	E 220	S 470	HT 375	M.EX AL 110
CL 70		E 145	E 250	S 600	HT 530	M.EX AL 115
CL 80		E 150	E 300	S 700		
		E 170 (Bz)	E 400	S 870		

ACERO

Serie M.EX FE (troquelada)	Serie R (perfilada)
M.EX FE 62	R 200
M.EX FE 76	R 220
M.EX FE 110	R 235
M.EX FE 115	R 250
	R 314
	R 355

MADERA

Serie CL MAD (maciza / Finger-Joint)	Serie P MAD (maciza)
CL MAD 35	P MAD 100
CL MAD 50	P MAD 150
CL MAD 80	

APLICACIONES



PARAMENTO MARCO FIJO CORREDERO PRACTICABLE BATIENTE PRACTICABLE PIVOTANTE PROYECTABLE CORRUGABLE BATIENTE CORRUGABLE PIVOTANTE LEVADIZO



Celosías de aluminio, **tubular** de lamas **extruidas**, fijas sobre marcos o montantes de aluminio extruido con portalamas y diferentes separaciones.

SERIE CL

PRODUCTOS

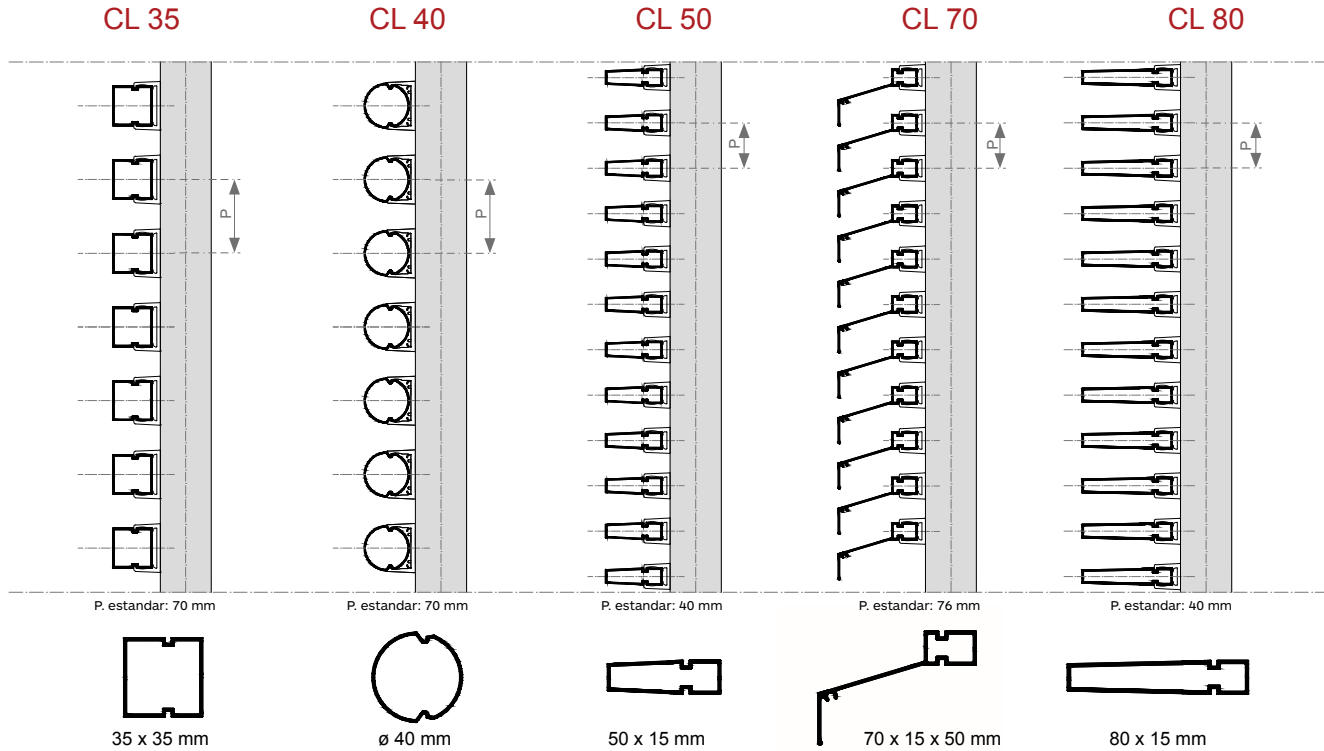

TIPOS DE MARCOS

TIPOS DE MONTANTES

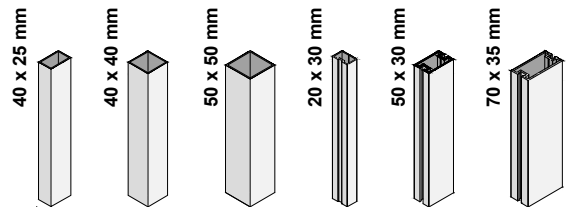
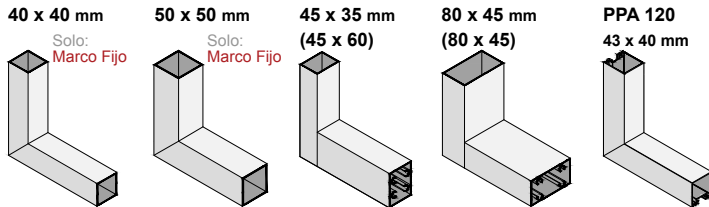

APLICACIONES



Celosías de aluminio, **tubular** de lamas **perfiladas**, fijas y orientables en marcos de aluminio extruido.

SERIE P

PRODUCTOS

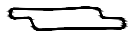
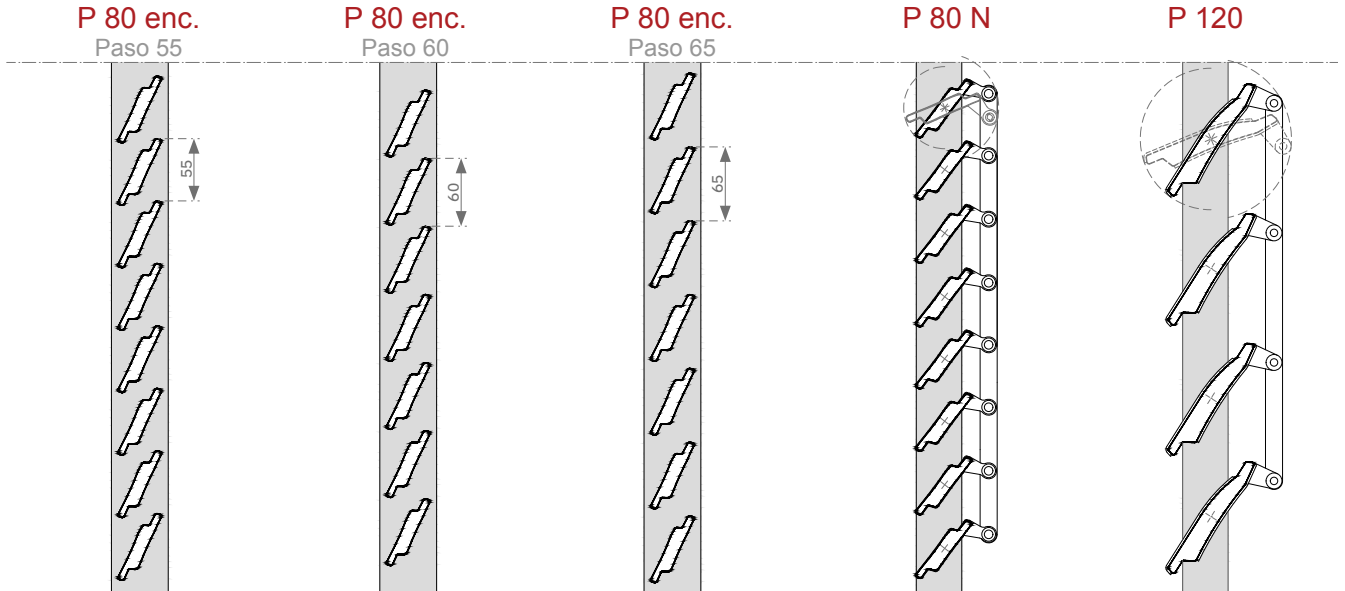

68 x 13 mm

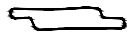

68 x 13 mm

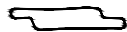

68 x 13 mm

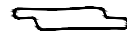

68 x 13 mm



120 x 18 mm

TIPOS DE MARCOS

P 80 enc.

TIPOS DE MARCOS

P 80 N | P 120

PPA

50 x 63 mm

PVA

50 x 46 mm

PVCC

50 x 45 mm

Solo:
Marco Fijo

40 x 25 mm

Solo:
Marco Fijo

40 x 40 mm

Solo:
Marco Fijo

50 x 50 mm

Solo:
Marco Fijo

45 x 35 mm

(45 x 60)

80 x 45 mm

(80 x 45)

PVA 120

40 x 26 mm

PPA 120

43 x 40 mm

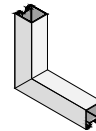
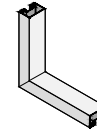
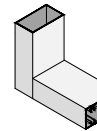
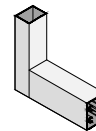
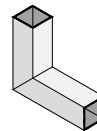
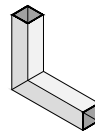
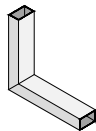
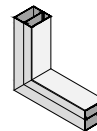
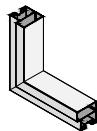
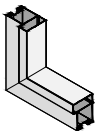

APLICACIONES



PARAMENTO



MARCO FIJO



CORREDERO



PRACTICABLE BATIENTE



PRACTICABLE PIVOTANTE
(Solo P 80 N y P 120)



PROYECTABLE



CORRUGABLE BATIENTE



CORRUGABLE PIVOTANTE
(Solo P 80 N y P 120)



LEVADIZO



GRADPANEL **CELOSÍAS** **ALUMINIO** **Serie E**

Celosías de aluminio, **tubular** de lamas **extruidas**, fijas y orientables en marcos y montantes de aluminio extruido.

SERIE E

PRODUCTOS

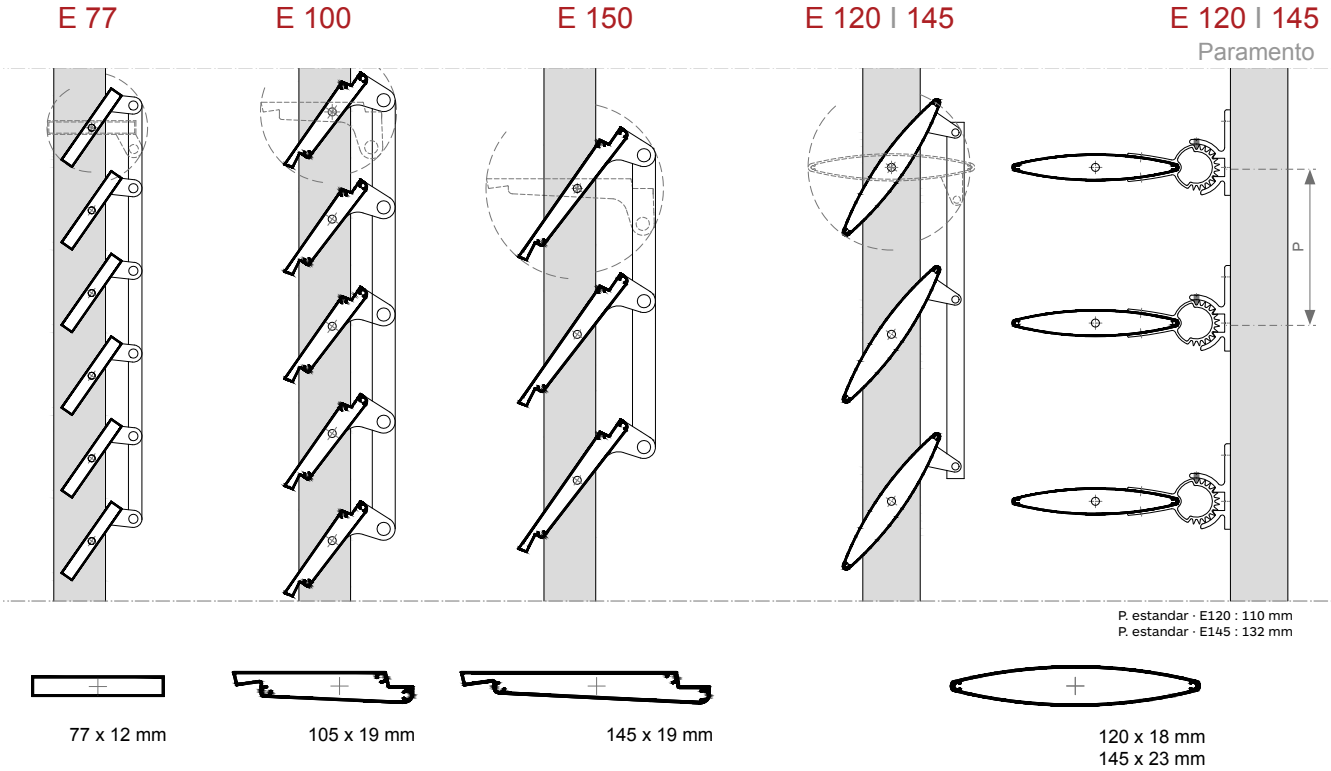

TIPOS DE MARCOS

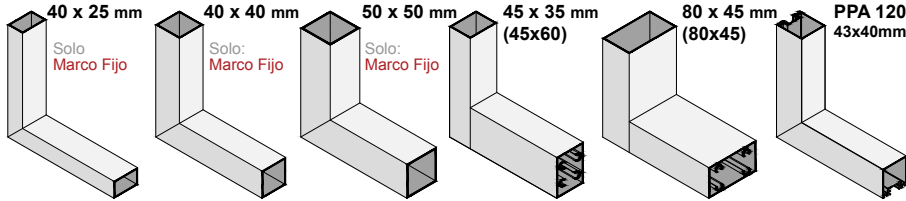

TIPOS DE MONTANTES (Solo Paramento)

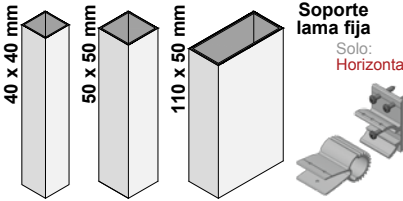

APLICACIONES

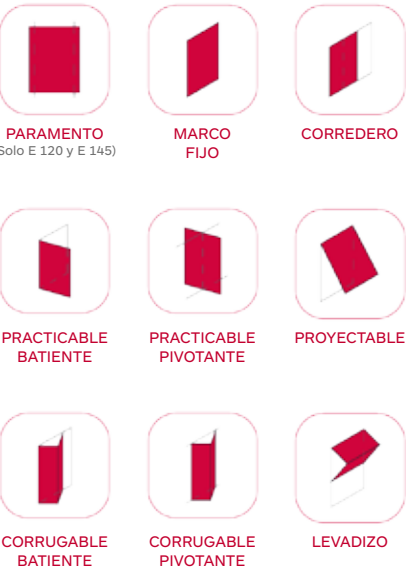

Celosías de aluminio, **tubular** de lamas **extruidas**, fijas y orientables en marcos y montantes de aluminio extruido.

SERIE E

PRODUCTOS

E 190 | 220 | 250 | 300

Marco fijo Orientable

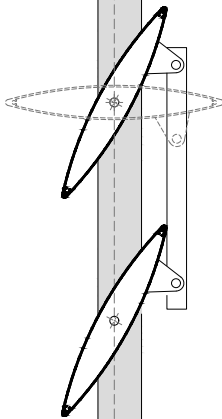

190 x 34 mm
220 x 35 mm
250 x 42 mm
300 x 52 mm

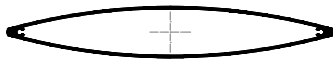

E 400

Marco fijo Orientable

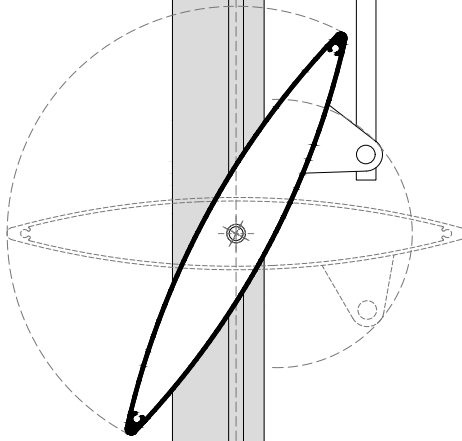

400 x 68 mm



E 190 | 220 | 250 | 300 | 400

Paramento

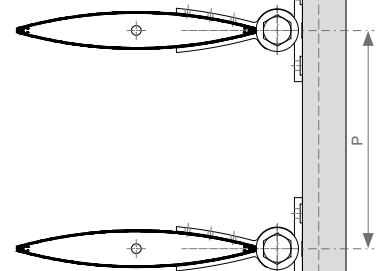

P. estandar E 190 : 173 mm
E 220 : 205 mm
E 250 : 228 mm
E 300 : 275 mm
E 400 : 370 mm

TIPOS DE MARCO

50 x 50 x 2

Solo E 190
E 220
E 250
E 300

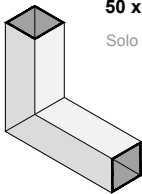

TIPOS DE MONTANTES

PERFIL PUERTA
40 x 50 mm

Solo E 400



PERFIL BALA
80 x 50 mm

Solo E 400



TIPOS DE MONTANTES (Solo Paramento)

40 x 40 mm
50 x 50 mm
110 x 50 mm

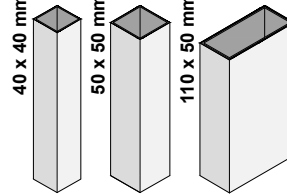

Soporte lama fija

Solo: Horizontal

Horizontal y Vertical

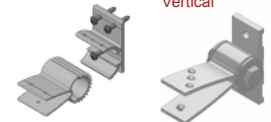

APLICACIONES



PARAMENTO



MARCO FIJO



CORREDERO



PRACTICABLE BATIENTE



PRACTICABLE PIVOTANTE



PROYECTABLE



CORRUGABLE BATIENTE



CORRUGABLE PIVOTANTE



LEVADIZO



GRADPANEL **CELOSÍAS** **ALUMINIO** **Serie E**

Celosías de aluminio, **tubular** de lamas **extruidas**, fijas y orientables en marcos y montantes de aluminio extruido o perfil sierra de acero galvanizado.

SERIE E

PRODUCTOS

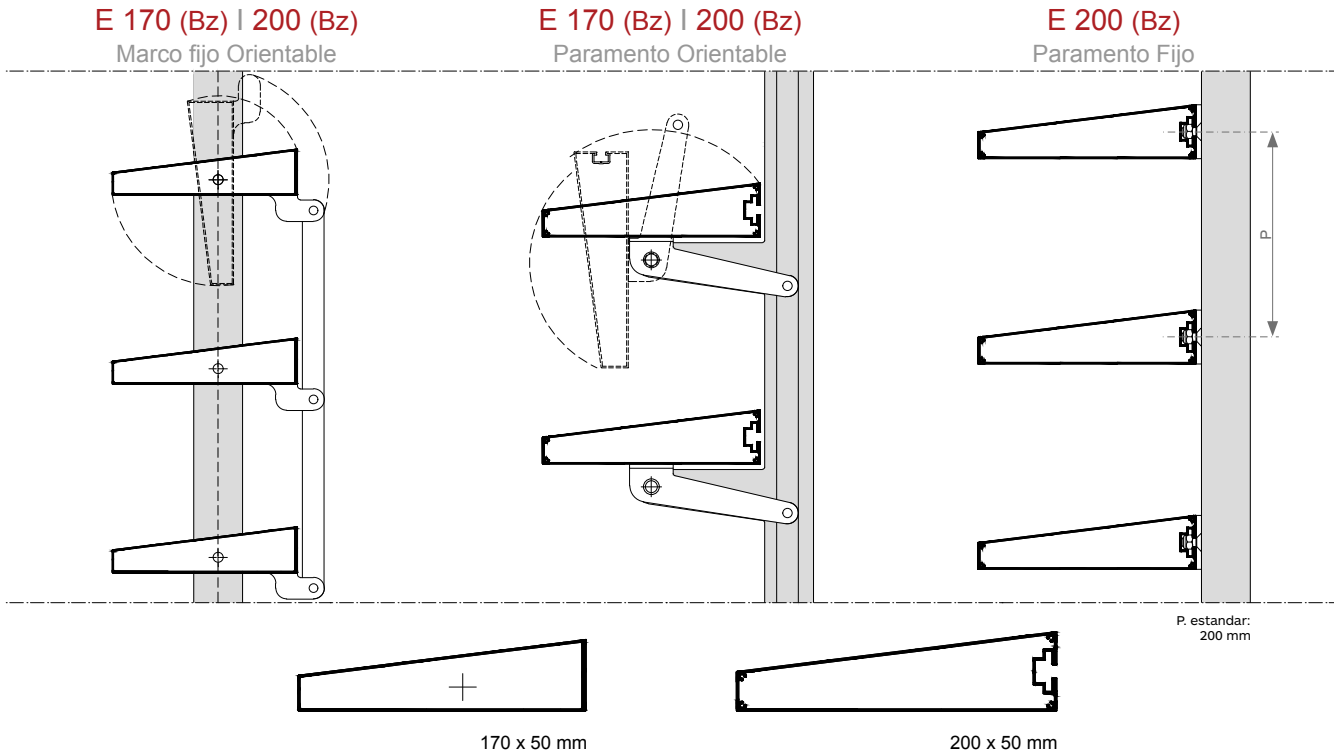

TIPOS DE MARCO

TIPO DE MONTANTES

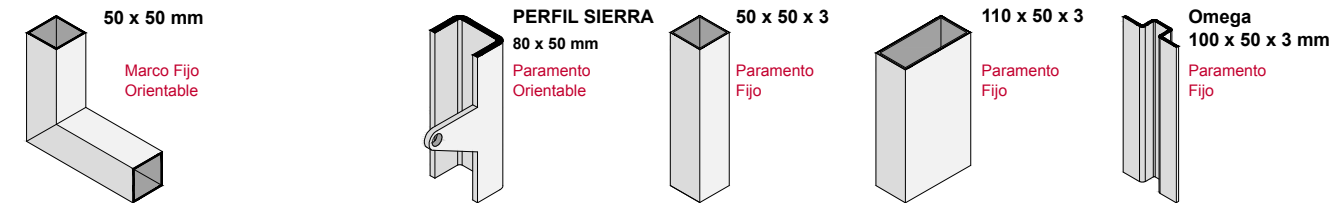

APLICACIONES

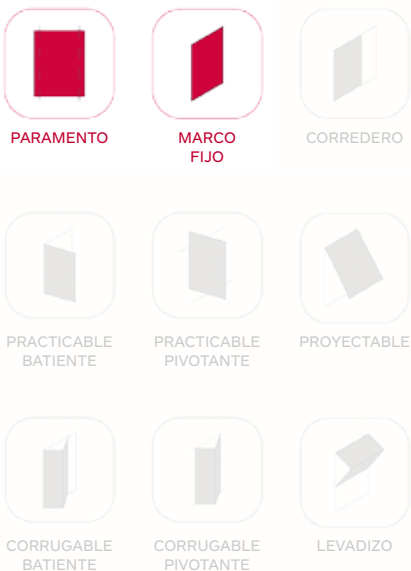

Celosías de aluminio, **tubular** y **monopared** de lamás **perfiladas**, fijas y orientables en montantes de aluminio extruido.

SERIE S (tubular) - **SERIE HT** (monopared)

PRODUCTOS

S 340 | 400 | 470 | 600 | 700 | 870

HT 205

HT 220 | 375 | 530

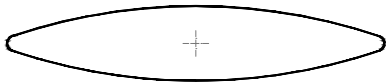
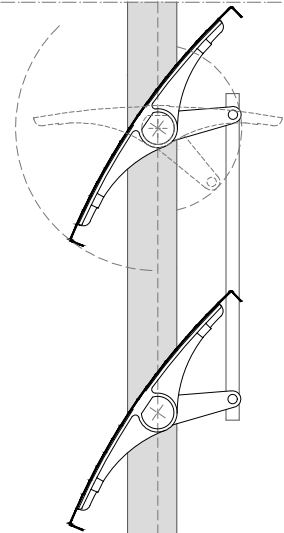
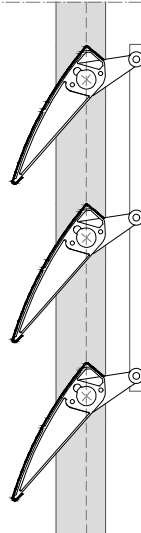
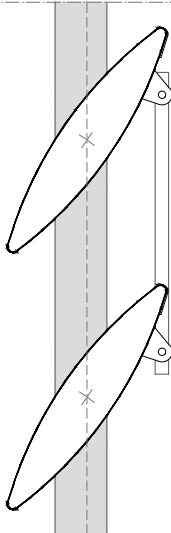

340 x 68 mm
400 x 80 mm
470 x 100 mm

585 x 120 mm
700 x 135 mm
870 x 120 mm



205 x 50 mm



220 x 56 mm
375 x 58 mm
530 x 98 mm

TIPOS DE MONTANTES

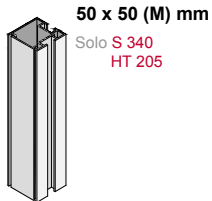

50 x 50 (M) mm
Solo S 340
HT 205

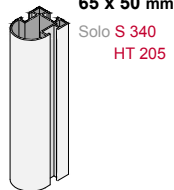

65 x 50 mm
Solo S 340
HT 205

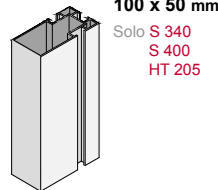

100 x 50 mm
Solo S 340
S 400
HT 205

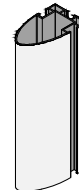

PERFIL BALA
100 x 60 mm
Excepto
HT 205

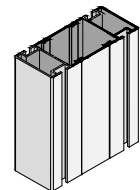

150 x 65 mm
Excepto
HT 205

APLICACIONES



PARAMENTO



MARCO FIJO



CORREDERO



PRACTICABLE
BATIENTE



PRACTICABLE
PIVOTANTE



PROYECTABLE



CORRUGABLE
BATIENTE



CORRUGABLE
PIVOTANTE



LEVADIZO



Celosías de aluminio, **tubular** de lamas **extruidas**, fijas y orientables en montantes de aluminio extruido.

SERIE BS

PRODUCTOS

BS 500

BS 1000

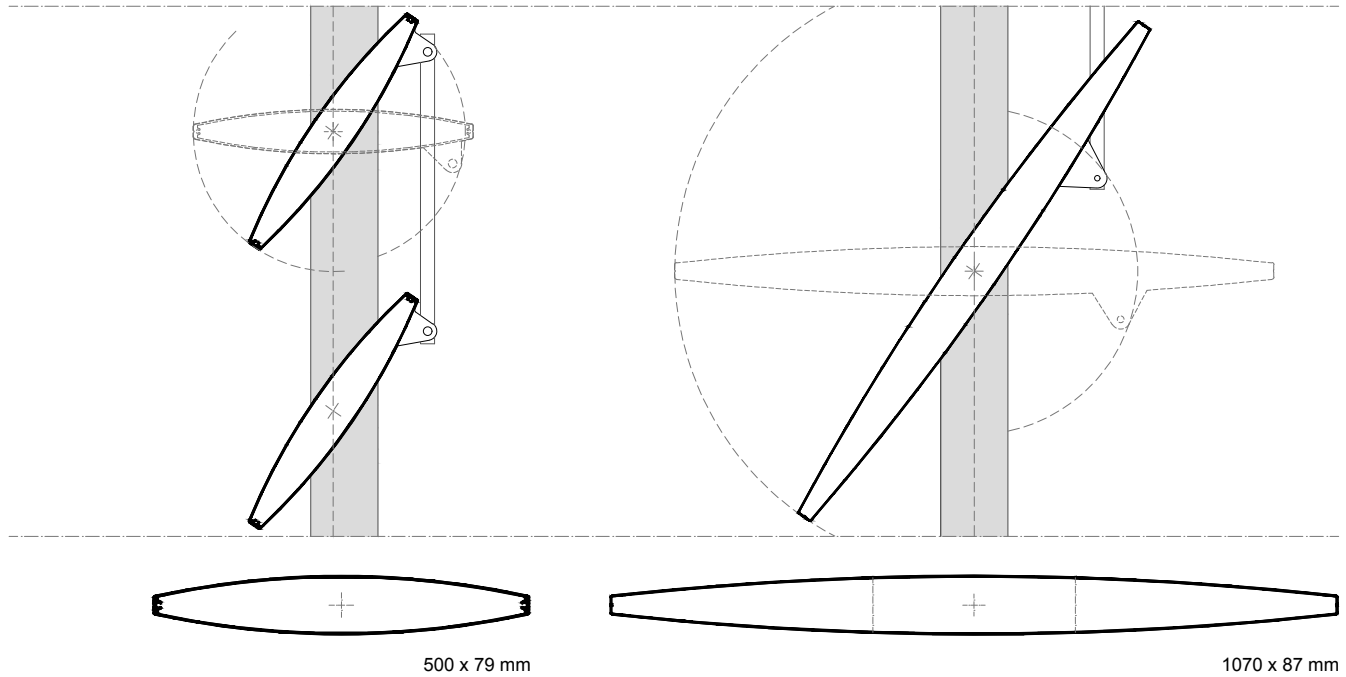

TIPOS DE MONTANTES



APLICACIONES

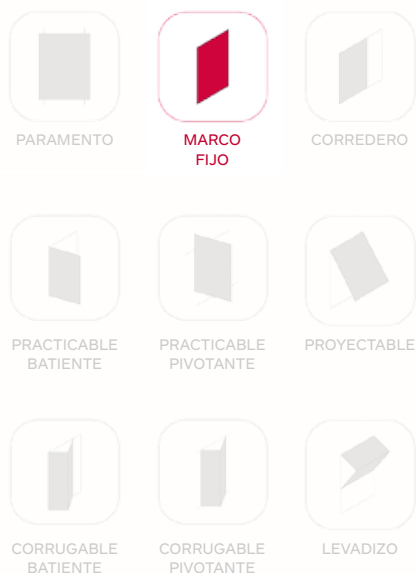



Celosías de aluminio de **mallá expandida**, de varias dimensiones de rombo, hilo y espesor, con **pletina de aluminio** soldada para la fijación a marcos de aluminio extruido.

SERIE M. EX AL

PRO-

115 x 48 - 20 x 1,5 (26%)

3,2 kg/m²

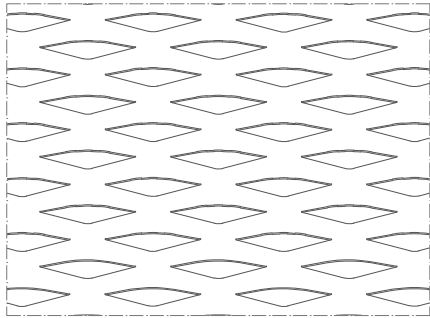

110 x 52 - 24 x 1,5 (16%)

3,6 kg/m²

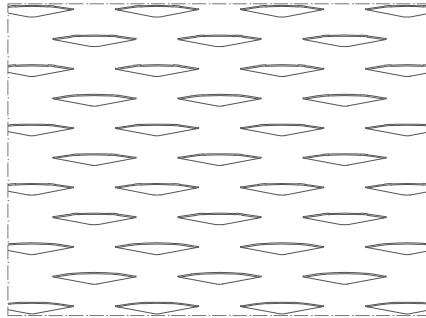

76 x 35 - 11 x 1,5 (42%)

2,6 kg/m²

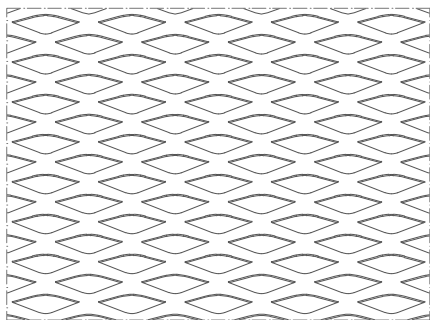

62 x 25 - 9,1 x 1,5 (42%)

2,7 kg/m²

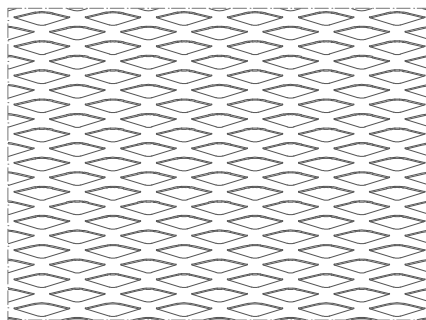

DL x DC - h x e

DL Diagonal Larga
DC Diagonal Corta
h Hilo
e Espesor

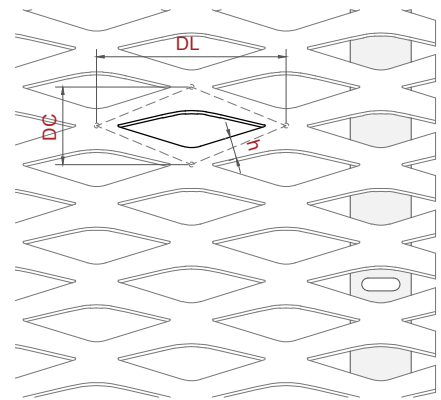

Detalle pletina soldada a la mallá para fijar en el marco.

TIPOS DE MARCOS

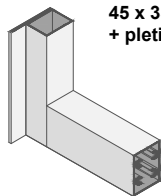

45 x 35 (60 x 45) mm + pletina

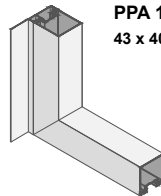

PPA 120 + pletina 43 x 40 mm

TIPO DE MONTANTE

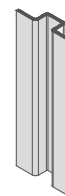

OMEGA 90 x 25 mm

APLICACIONES



PARAMENTO



MARCO FIJO



CORREDERO



PRACTICABLE BATIENTE



PRACTICABLE PIVOTE



PROYECTABLE



CORRUGABLE BATIENTE



CORRUGABLE PIVOTE



LEVADIZO



Celosías de acero de **malla expandida**, de varias dimensiones de rombo, hilo y espesor, con **pletina de acero** soldada para la fijación a marcos de aluminio extruido.

SERIE M. EX FE

PRODUCTO

115 x 48 - 20 x 1,5 (26%)

9,7 kg/m²

110 x 52 - 24 x 1,5 (16%)

10,6 kg/m²

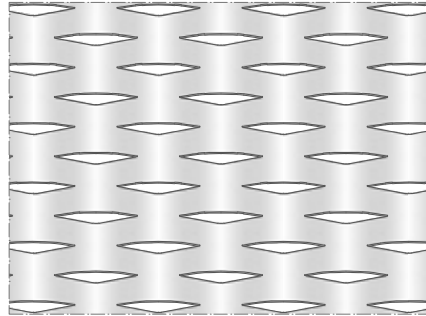
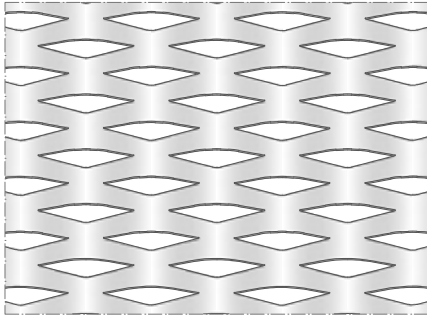

76 x 35 - 11 x 1,5 (42%)

7,8 kg/m²

62 x 25 - 9,1 x 1,5 (42%)

8,2 kg/m²

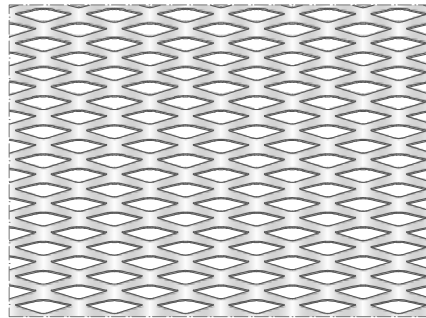
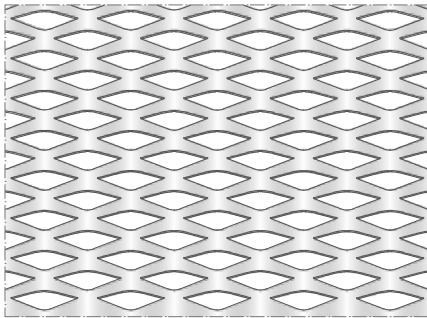

DL x DC - h x e

DL Diagonal Larga

DC Diagonal Corta

h Hilo

e Espesor

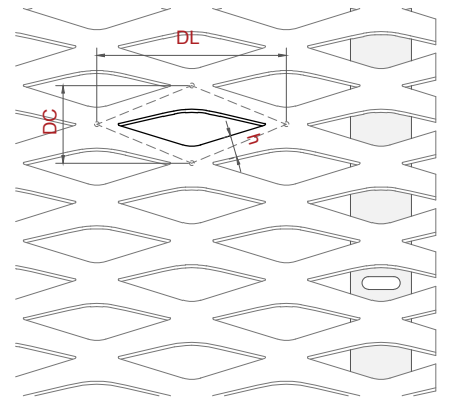

Detalle pletina soldada a la malla para fijar en el marco.

TIPOS DE MARCOS

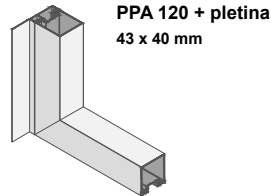
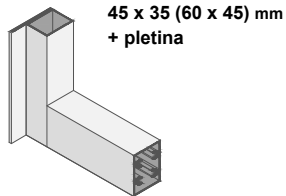

TIPO DE MONTANTE

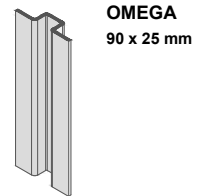

APLICACIONES



PARAMENTO



MARCO FIJO



CORREDERO



PRACTICABLE BATIENTE



PRACTICABLE PIVOTANTE



PROYECTABLE



CORRUGABLE BATIENTE



CORRUGABLE PIVOTANTE



LEVADIZO



GRADPANEL **CELOSÍAS** **ACERO** **Serie R**

Celosías de acero galvanizado, **tubular** de lamas **perfiladas**, fijas y orientables en marcos y montantes de aluminio extruido.

SERIE R PRODUCTOS

R 200 | 220 | 235 | 250

R 314 | 335 | 400

R 480 | 500 | 600

R 620

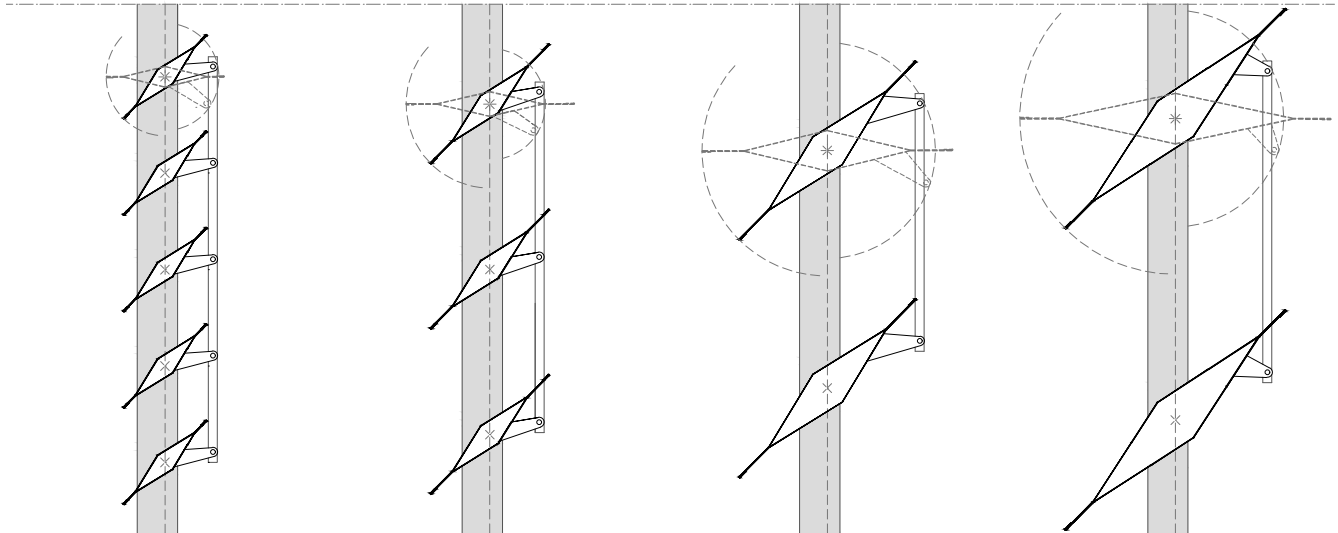

200 x 40 mm
220 x 40 mm
235 x 40 mm
250 x 40 mm



314 x 50 mm
335 x 50 mm
400 x 50 mm



480 x 80 mm
500 x 80 mm
600 x 80 mm



620 x 100 mm

TIPOS DE MARCOS

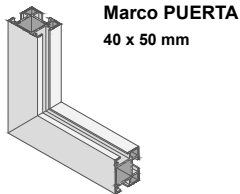

Marco PUERTA
40 x 50 mm

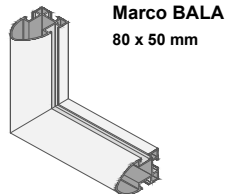

Marco BALA
80 x 50 mm

TIPOS DE MONTANTES

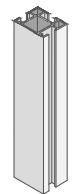

PERFIL PUERTA
40 x 50 mm



PERFIL BALA
80 x 50 mm

APLICACIONES



PARAMENTO



MARCO FIJO



CORREDERO



PRACTICABLE
BATIENTE



PRACTICABLE
PIVOTANTE



PROYECTABLE



CORRUGABLE
BATIENTE



CORRUGABLE
PIVOTANTE



LEVADIZO

SOPORTE REGULABLE para aplicación PARAMENTO



Celosías de acero galvanizado, **tubular** de lamas **perfiladas**, fijas y orientables en marcos y montantes de aluminio extruido.

SERIE R

CLASIFICACIÓN

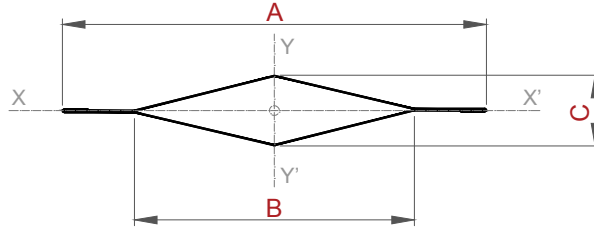

* Norma UNE "Resistencia al viento"

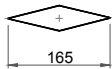
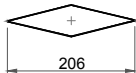
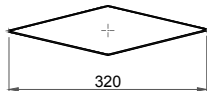
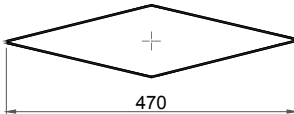
SERIE R			LONGITUDES MÁXIMAS (mm)			
Cota B [mm]	Cota A [mm]	Cota C [mm]	PANEL HORIZONTAL		PANEL VERTICAL	
			GH	Clase 6*	GH	Clase 6*
ROMBO 	200	40	3200	3000	3378	3250
	220	40	3100	2950	3278	3150
	235	40	3000	2850	3278	3100
	250	40	3000	2850	3178	3050
ROMBO 	250	40	3800	3800	4378	4200
	314	50	3700	3550	4078	3900
	335	50	3900	3750	4178	4000
	400	50	3800	3650	4178	4000
ROMBO 	400	50	5700	5500	6378	6150
	480	80	5400	5200	5978	5850
	500	80	5400	5200	5978	5850
	600	80	5100	4950	5678	5550
ROMBO 	600	100	6550	6400	6528	7150
	620	100	6550	6400	6528	7100

Medidas superiores a 6 m consultar



GRADPANEL **CELOSÍAS** **MADERA** **Serie CL MAD**

Celosías de lamas de madera maciza de **Cedro Rojo**, fijas sobre marcos o montantes de aluminio extruido con portalamas y diferentes separaciones.

SERIE CL MAD

PRODUCTOS

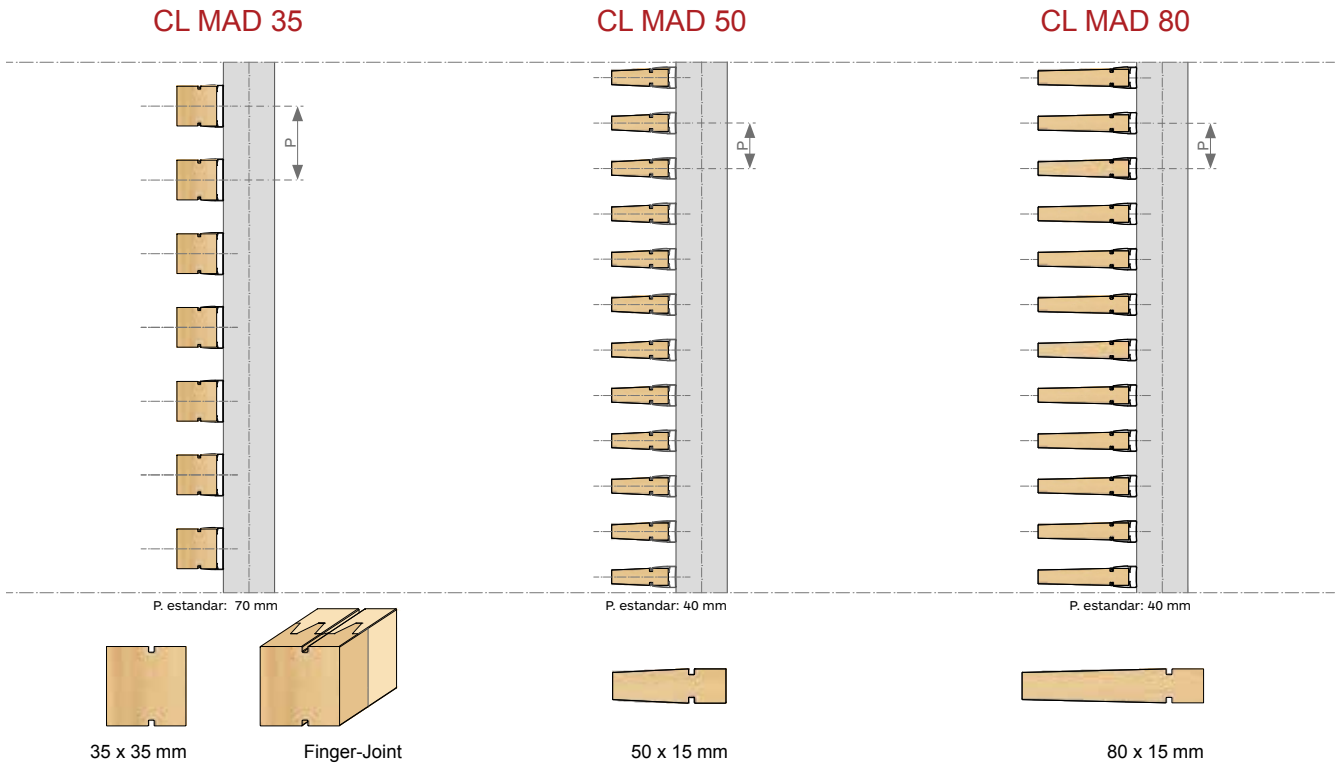

TIPOS DE MARCOS

TIPOS DE MONTANTES

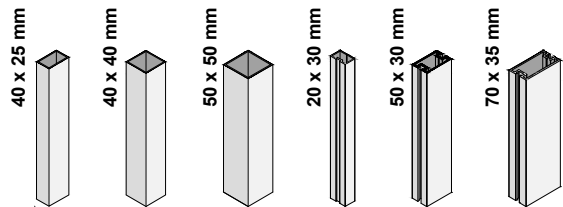
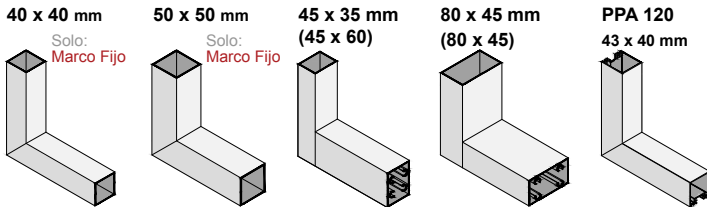

APLICACIONES

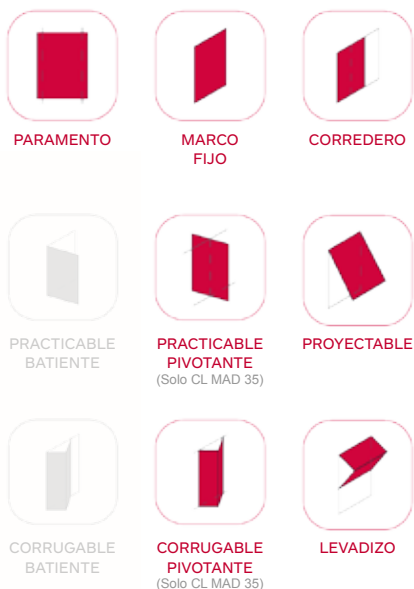

Celosías de lamas de maderas macizas de **Cedro Rojo**, fijas y orientables en marcos de aluminio extruido.

SERIE P MAD

PRODUCTOS

P MAD 100

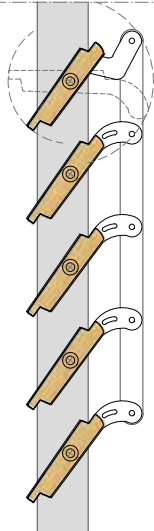

95 x 19 mm

P MAD 150

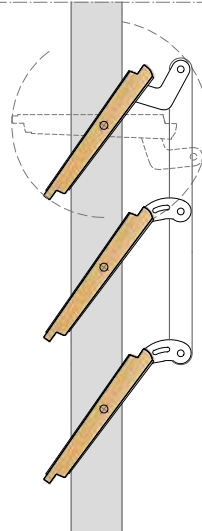

145 x 19 mm

TIPOS DE MARCOS

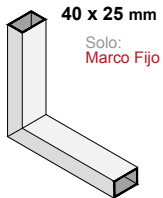

40 x 25 mm
Solo:
Marco Fijo

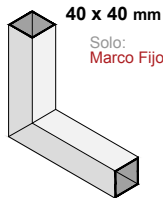

40 x 40 mm
Solo:
Marco Fijo

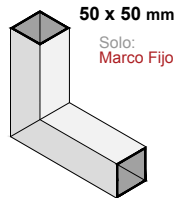

50 x 50 mm
Solo:
Marco Fijo

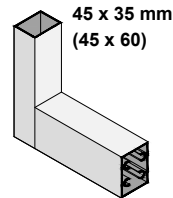

45 x 35 mm
(45 x 60)

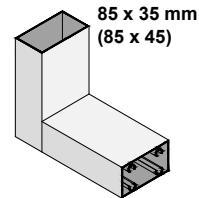

85 x 35 mm
(85 x 45)

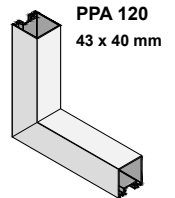

PPA 120
43 x 40 mm

APLICACIONES



PARAMENTO



MARCO FIJO



CORREDERO



PRACTICABLE
BATIENTE



PRACTICABLE
PIVOTANTE



PROYECTABLE



CORRUGABLE
BATIENTE



CORRUGABLE
PIVOTANTE



LEVADIZO



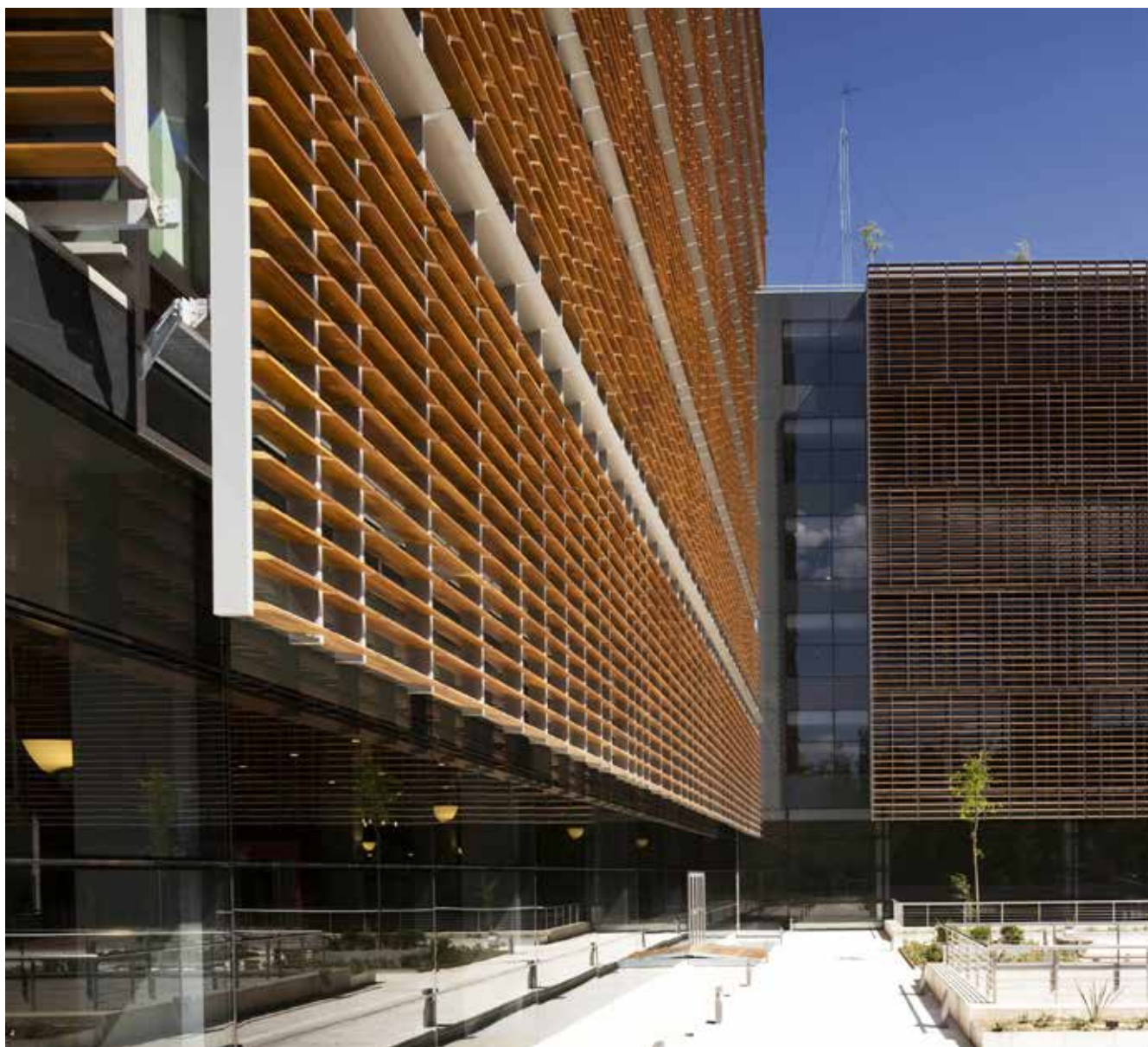

SISTEMAS DE CELOSÍAS

Singular *Llambí*

Los sistemas de celosías singulares, desarrolladas por el departamento Llambí, se adaptan para atender las necesidades del proyecto y hacer la idea una realidad con elementos de protección solar de materiales como la Cerámica, Composite, Zinc, Hormigón, Vidrio, Policarbonato, Baquelizado, Madera, Aluminio, etc...

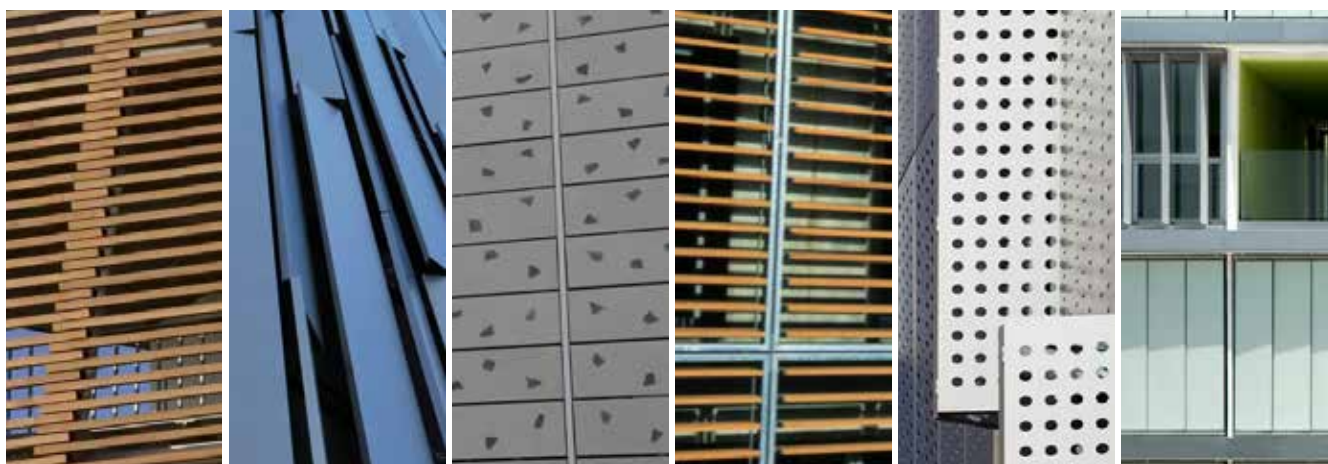

SISTEMAS DE CELOSÍAS

SINGULAR

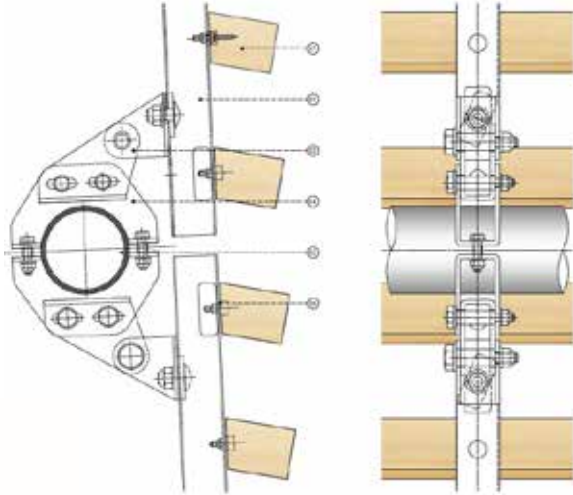
CENTRO DE INVESTIGACIÓN BIOMÉDICADe Pineda - Brullet - De Luna, 2006
Barcelona (España)*LISTONES DE MADERA DE CEDRO*

- 01 - Listón de madera de Cedro
- 02 - Montante vertical de acero galvanizado
- 03 - Fijación de subestructura
- 04 - Abrazadera a estructura principal
- 05 - Tubo estructural curvo
- 06 - Anclaje regulable encastrado

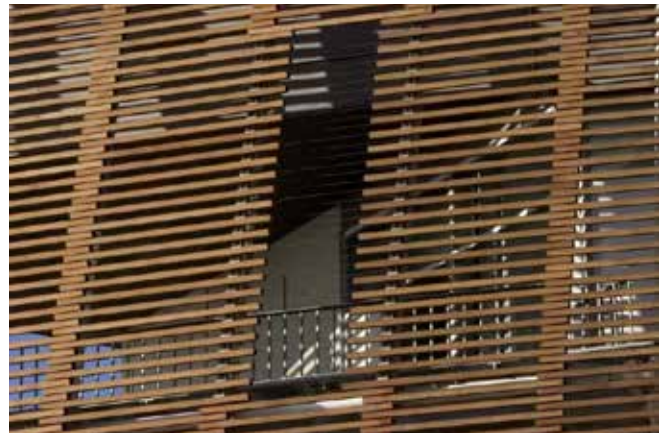
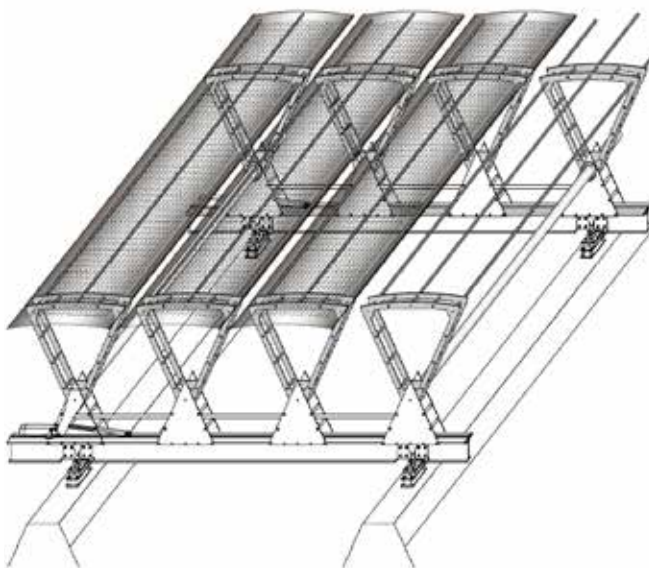
**HOSPITAL DE ALCORCÓN**Luis Fernández - Carlos Ferrán, 1998
Alcorcón (España)*LAMAS DE ALUMINIO*

SIÈGE DU GOUVERNEMENT DU LOT

Brochet - Lajus - Pueyo, 2007
Cahors (Francia)

LAMAS DE HORMIGÓN

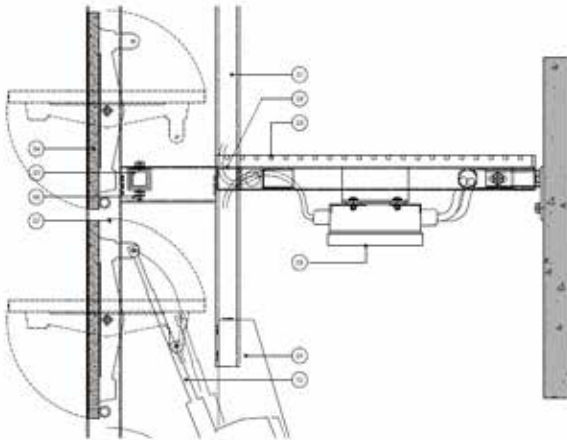

- 01 - Tubo de acero galvanizado 60x40
- 02 - Marco soporte malla tubo 40x40
- 03 - Malla electrosoldada
- 04 - Lama de hormigón prefabricado
- 05 - Travesaño horizontal 40x40
- 06 - Ménsula tubo 60x20
- 07 - Montante vertical 60x20
- 08 - Caja de conexiones estanca
- 09 - Cartela de fijación de motor
- 10 - Motor de accionamiento orientación lamas



BUREAU DU DÉPARTEMENT DU TRÉSOR

Brochet - Lajus - Pueyo, 2001
Limoges (Francia)

LAMAS CERÁMICAS

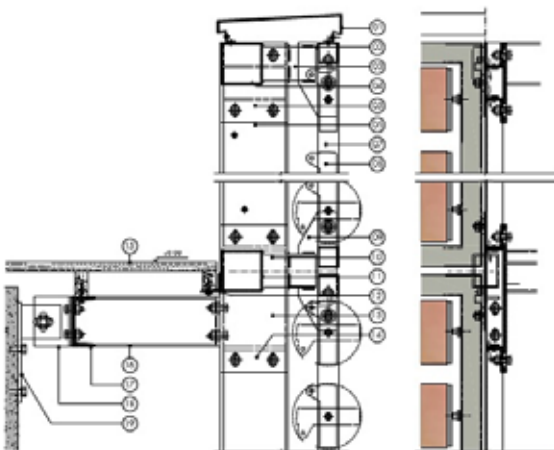

- 01 - Remate coronación de chapa plegada de acero galvanizado
- 02 - Cartela de fijación de marco soldada a IPE-160
- 03 - Soporte fijación cartela superior
- 04 - Travesaños horizontales de acero galvanizado
- 05 - Rigidizador unión superior
- 06 - IPE-160
- 07 - Bastidor portalamas de acero galvanizado
- 08 - Lama cerámica con testeros de acero y barras internas de seguridad
- 09 - Cartela central de fijación
- 10 - Soporte de fijación de cartela central



- 11 - Travesaño horizontal
- 12 - Angular de fijación pavimento azotea
- 13 - Platabandas rigidizadoras
- 14 - Rigidizadores de unión
- 15 - Pavimento flotaante azotea
- 16 - Ménsula IPE-120
- 17 - UPE-120 de amidamiento
- 18 - Pieza de unión perfil de arriostramiento
- 19 - Anclaje a forjado superior

RESIDENCIA DOLORS ALEU

Albert De Pineda, 2010
Barcelona (España)

PANELES DE COMPOSITE

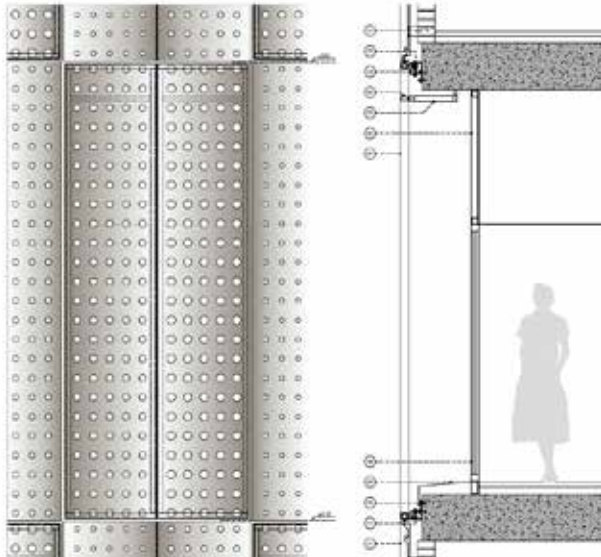

- 01 - Fachada ventilada panel composite
- 02 - Anclaje a forjado de acero
- 03 - Guía superior de aluminio extruido
- 04 - Marco de acero galvanizado
- 05 - Mecanismo de apertura motorizado
- 06 - Cerramiento de chapa de aluminio
- 07 - Panel composite
- 08 - Carpintería de aluminio
- 09 - Vierteaguas de chapa plegada
- 10 - Guía inferior de aluminio extruido



RESIDENCIAL MARE DE DEU DEL PORT

Blanca Lleó, 2010
Barcelona (España)

LAMA DE PANEL FENÓLICO

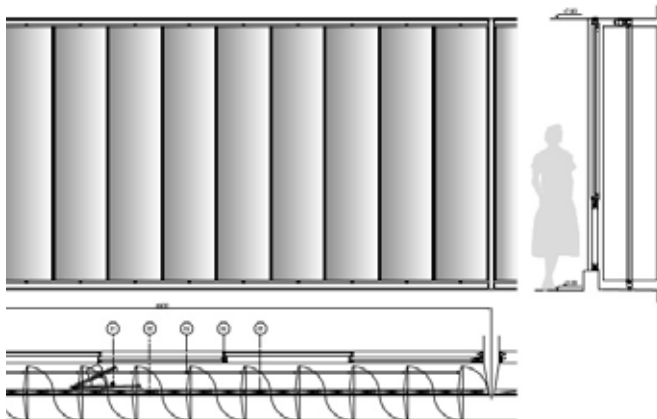

- 01 - Motor de accionamiento
- 02 - Lama mixta con acabado de panel fenólico y alma de acero
- 03 - Mando de accionamiento
- 04 - Carpintería de aluminio
- 05 - Tubo soporte de acero





SISTEMAS DE CELOSÍAS

Especificaciones Técnicas



CARTA DE ACABADOS







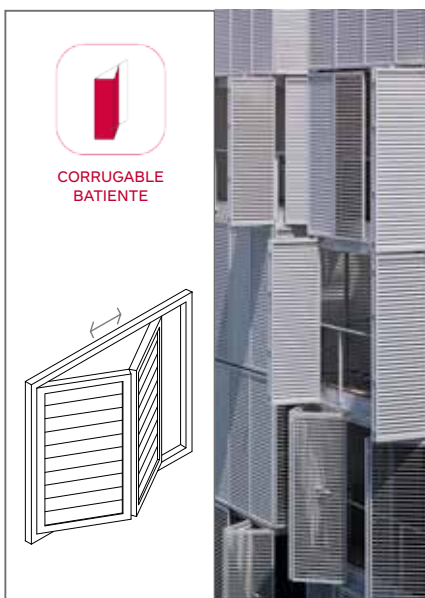
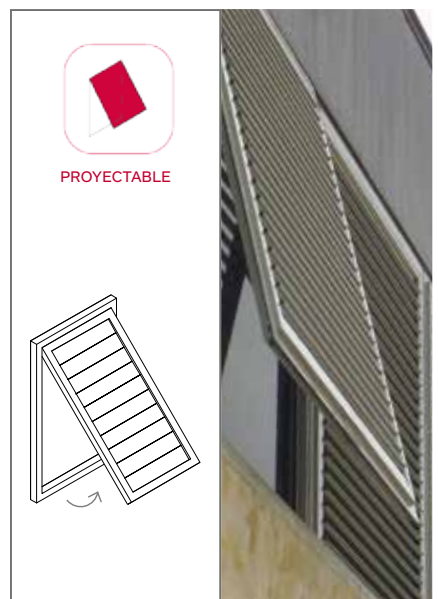
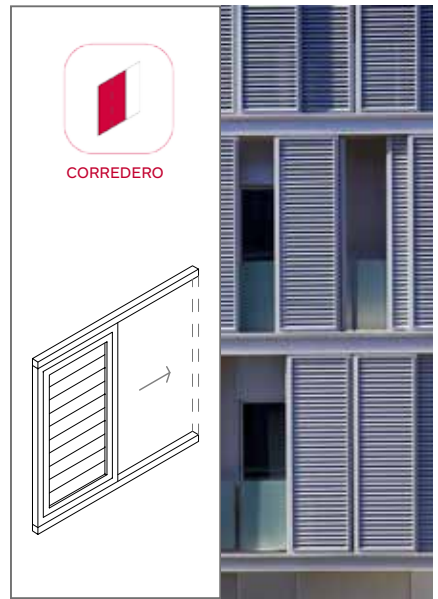

PRODUCTO		SERIE		ACABADO				
				PINTURA EN POLVO	PINTURA COIL COATING	ANODIZADO PLATA - MATE	TRATAMIENTO LASUR	COLOR INYECTADO
PHALSOL	ALUMINIO	PH	Viguetas	—	✓	—	—	—
			Lamas	—	✓	—	—	—
		C	Montantes	✓	—	○	—	—
			Lamas	✓	—	○	—	—
GRADPANEL	ALUMINIO	CL	Marcos y Montantes	✓	—	○	—	—
			Lamas	✓	—	○	—	—
		P	Marcos	✓	—	—	—	—
			Lamas	—	✓	—	—	—
		E	Marcos y Montantes	✓	—	○	—	—
			Lamas	✓	—	○	—	—
		S	Montantes	✓	—	○	—	—
			Lamas	✓	✓	—	—	—
		HT	Montantes	✓	—	○	—	—
			Lamas	✓	✓	○	—	—
		BS	Montantes	✓	—	○	—	—
			Lamas	✓	—	○	—	—
	M.EX AL	Marcos	✓	—	○	—	—	
		Malla	✓	—	○	—	—	
	ACERO	M.EX FE	Marcos	✓	—	○	—	—
			Malla	—	—	—	—	—
		R	Marcos y Montantes	✓	—	○	—	—
			Lamas	—	—	—	—	—
	MADERA	CL MAD	Marcos y Montantes	✓	—	○	—	—
			Lamas	—	—	—	○	—
P MAD		Marcos	✓	—	○	—	—	
		Lamas	—	—	—	○	—	
Singular				SEGÚN ESTUDIO				

✓ (SI), ○ (con suplemento), — (NO)

APLICACIONES



APLICACIONES. Tabla

Lamas	PHALSOL			GRADPANEL															
Material	ALUMINIO			ALUMINIO										ACERO		MADERA			
Serie	PH	C		CL	P		E			S	HT	BS	M.EX AL	M.EX FE	R	CL MAD	P MAD		
PRODUCTO	34 84 U 31 U 81	100 130	150 160 180	35 40 50 70 80	80 enc.	80 N 120	77 100 120 145 150	170 (Bz) 200(Bz)	190 220 250 300 400	340 400 470 600 700 870	205 220 375 530	500 1000	62x25 76x35 110x52 115x48	62x25 76x35 110x52 115x48	200 220 235 250 314 335 400 480 600 620	35 50 80	100 150		
 Paramento	F	✓	✓	✓	✓	—	—	—	✓	✓	✓	✓	—	✓	✓	✓	✓	—	
	O	—	—	—	—	—	—	—	✓	—	—	—	—	—	—	—	—	—	
 Marco Fijo	F	—	—	—	✓	✓	✓	✓	✓	✓	✓	✓	✓	✓	✓	✓	✓	✓	
	O	—	—	—	—	—	✓	✓	✓	✓	✓	✓	—	—	✓	—	—	✓	
 Corredero	F	—	—	—	✓	✓	✓	—	—	—	—	—	✓	✓	—	✓	✓		
	O	—	—	—	—	—	✓	✓	—	—	—	—	—	—	—	—	—	✓	
 Practicable Batiente	F	—	—	—	—	✓	✓	✓	—	—	—	—	✓	✓	—	—	—	✓	
	O	—	—	—	—	—	✓	✓	—	—	—	—	—	—	—	—	—	✓	
 Practicable Pivotante	F	—	—	—	Solo CL 35 CL 40	—	✓	✓	—	—	—	—	✓	✓	—	Solo CL MAD 35	—	✓	
	O	—	—	—	—	—	✓	✓	—	—	—	—	—	—	—	—	—	—	✓
 Proyectable	F	—	—	—	✓	✓	✓	—	—	—	—	—	✓	✓	—	✓	✓		
	O	—	—	—	—	—	✓	✓	—	—	—	—	—	—	—	—	—	—	✓
 Corrugable Batiente	F	—	—	—	—	✓	✓	✓	—	—	—	—	✓	✓	—	—	—	—	✓
	O	—	—	—	—	—	✓	✓	—	—	—	—	—	—	—	—	—	—	✓
 Corrugable Pivotante	F	—	—	—	Solo CL 35 CL 40	—	✓	✓	—	—	—	—	✓	✓	—	Solo CL MAD 35	—	—	✓
	O	—	—	—	—	—	✓	✓	—	—	—	—	—	—	—	—	—	—	—
 Levadizo	F	—	—	—	✓	✓	✓	✓	—	—	—	—	✓	✓	—	✓	✓		
	O	—	—	—	—	—	✓	✓	—	—	—	—	—	—	—	—	—	—	✓

* F: Fijo, O: Orientable, ✓(SI), — (NO)

Cotas en mm

mm	VIGUETA U	VIGUETA OMEGA	Montant. 40x25	Montant. 40x40	Montant. 50x50 ₂	Montant. 20x30	Montant. 50x30	Montant. 70x35	Marco 40x25	Marco 40x40	Marco 50x50	Marco 45x35 (45x60)	Marco 80x45 (80x45)	Marco PVCC	Marco 50x50 M	Marco 65x50	Marco 100x50	Marco 100x60	Marco 150x60	Montant. SIERRA 80x50	Montant. BALA 80x50	Montant. PUERTA 40x50	
PH 84	900																						
PH 134	900																						
PH U 31	900																						
PH U 81	900																						
C 100								1600															
C 130								1600															
C 150								1800															
C 160								2200															
C 180								1800															
CL 35							1500					1500											
CL 40							1500					1500											
CL 50							1500					1500											
CL 70							1500					1500											
CL 80							1500					1500											
P 80 enc.														1750									
P 80 N											1500												
P 120											2625												
E 77											1725												
E 100											1800												
E 150											2200												
E 120											2005												
E 145											2610												
E 190					3505						3505											3505	
E 170 Bz	Medidas según estudio																						
E 200 Bz	Medidas según estudio																						
E 220					3619						3619											3664	
E 250					4169						4169											4214	
E 300					5014						5014											5014	
E 400																						5866	
S 340																5000							
S 400																	6000						
S 470																		8000					
S 600																			8000				
S 700																				8000			
S 870																					5000		
HT 205																2500							
HT 220																					2750		
HT 375																					3500		
HT 530																					5000		
BS 500	Medidas según estudio																						
BS 1000	Medidas según estudio																						
M.EX AL	Medidas según aplicación																						
M.EX FE	Medidas según aplicación																						
CL MAD 35							1500					1500											
CL MAD 50							1350					1350											
CL MAD 80							1350					1350											
P MAD 100												1200											
P MAD 150												1200											
Serie R	Medidas en Tabla página 21																						

Cotas en mm

mm	VIGUETA U	VIGUETA OMEGA	Montant. 40x25	Montant. 40x40	Montant. 50x50 ₂	Montant. 20x30	Montant. 50x30	Montant. 70x35	Marco 40x25	Marco 40x40	Marco 50x50	Marco 45x35 (45x60)	Marco 80x45 (80x45)	Marco PVCC	Marco 50x50 M	Marco 65x50	Marco 100x50	Marco 100x60	Marco 150x60	Montant. SIERRA 80x50	Montant. BALA 80x50	Montant. PUERTA 40x50	
PH 84	900																						
PH 134	900																						
PH U 31	900																						
PH U 81	900																						
C 100								1600															
C 130								1600															
C 150								1800															
C 160								2200															
C 180								1800															
CL 35							1500						1500										
CL 40							1500						1500										
CL 50							1500						1500										
CL 70							1500						1500										
CL 80							1500						1500										
P 80 enc.														1750									
P 80 N													1500										
P 120													2500										
E 77													1590										
E 100													1800										
E 150													2200										
E 120													1850										
E 145													2350										
E 190						3200							3200										3200
E 170 Bz	Medidas según estudio																						
E 200 Bz	Medidas según estudio																						
E 220						3269							3269										3269
E 250						3769							3769										3769
E 300						4614							4614										4614
E 400																							5606
S 340																	5000						
S 400																		6000					
S 470																							8000
S 600																							8000
S 700																							8000
S 870																							5000
HT 205																	2500						
HT 220																							2750
HT 375																							3500
HT 530																							5000
BS 500	Medidas según estudio																						
BS 1000	Medidas según estudio																						
M.EX AL	Medidas según aplicación																						
M.EX FE	Medidas según aplicación																						
CL MAD 35																							1500
CL MAD 50																							1350
CL MAD 80																							1350
P MAD 100																							1200
P MAD 150																							1200
Serie R	Medidas en Tabla página 21																						



Fábrica y oficinas: Avda. Béjar, 345
08226 Terrassa - Barcelona (España)
Tel. 93 735 44 08 Fax 93 735 65 43
www.gradhermetic.com info@gradhermetic.com



Delegaciones:

Barcelona Tel. 93 219 47 00 / Madrid Tel. 91 641 21 12 / Bilbao Tel. 94 671 13 18 /
Sevilla Tel. 95 563 04 51 / Valencia Tel. 96 369 64 13 / Valladolid Tel. 983 29 55 11 /
Málaga Tel. 952 23 98 77 / Zaragoza Tel.976 125 070 / Vigo Tel. 986 26 30 12

Div. internacional:

Francia Tel. +33 1 609 13 377 / Italia Tel. +393 663 14 68 / Marruecos Tel. +34 628 114 125 /
Chile Tel. +56 9 612 59 265 / Israel Tel. +34 626 407 512 / Portugal Tel. +34 629 806 985



UNE 13659:2004
Clase técnica: 6

