

Alzado  
E: 1/4

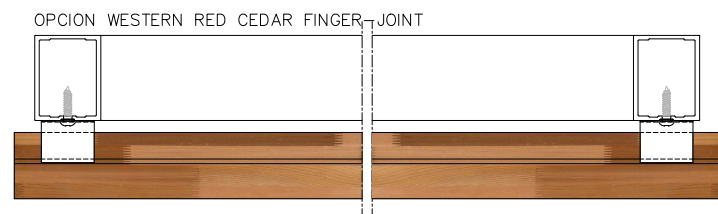

Planta  
E: 1/4

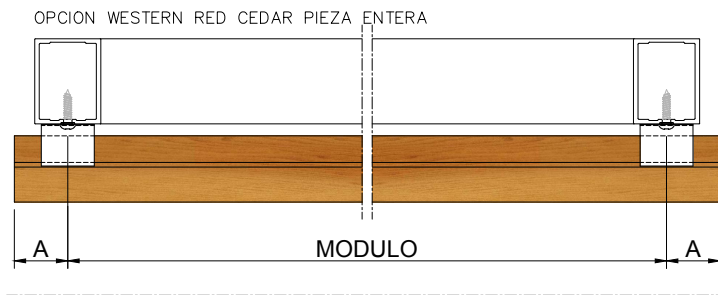
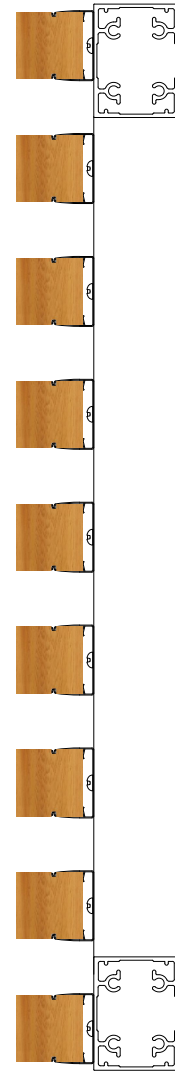

Sección  
E: 1/4

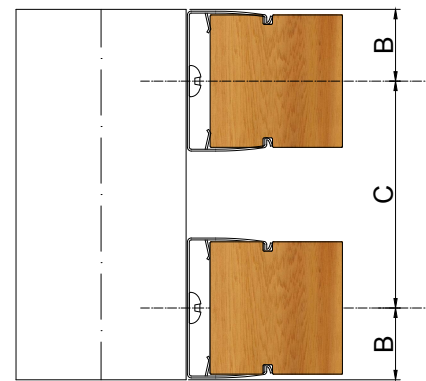
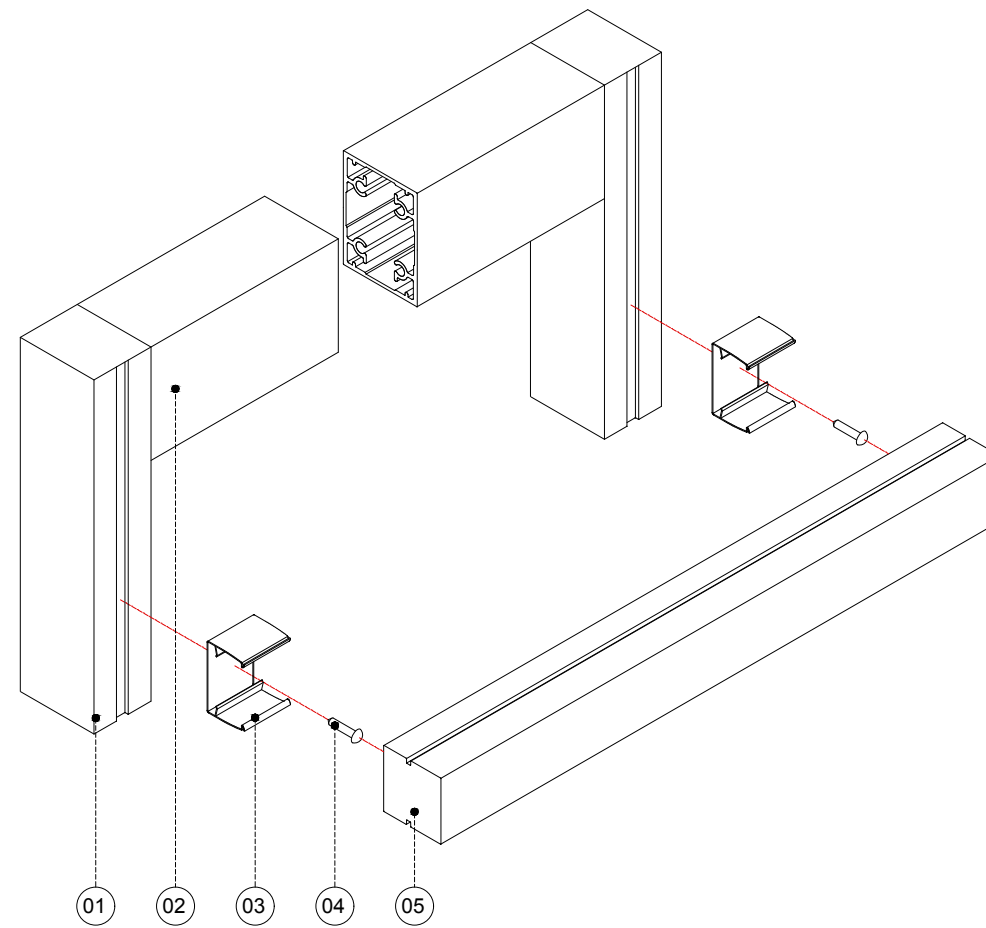

**B**  
INICIO Y FINAL  
Máx. no limitado  
Mín. 19 mm\*

**C**  
REPARTO  
Máx. no limitado  
Mín. 44 mm

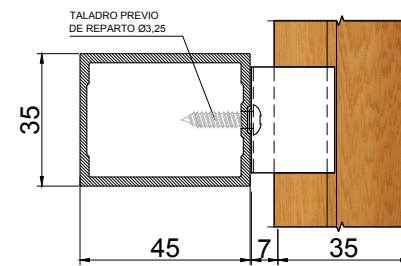

**Descripción:**

Conjunto CL MAD 35

**Aplicación:**  
Marco Fijo

- 1 – Montante vertical
- 2 – Travesaño horizontal
- 3 – Pinza
- 4 – Tornillo
- 5 – Lama CL MAD 35

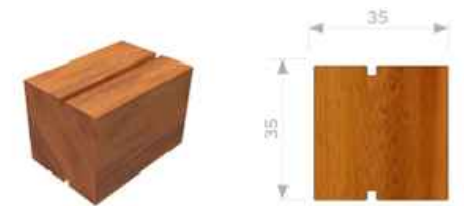

**Título plano:**

CONJUNTO CL MAD 35  
Marco Fijo

**Familia:**  
CELOSÍAS

**Clasificación:**  
GRADPANEL > Madera >  
> Serie CL MAD > CL MAD 35

**Autor:** GRADHERMETIC  
Industrial Gradhermetic, S.A.E.

**Escala:** Según plano (DIN-A3)

**Revisión:** v1

